

Varenummer: 03449200  
 Beskrivelse: Fluro Heavy Duty Ledleje GE 200 SWE  
 Hul Ø200  
 Note: 200

## Mål

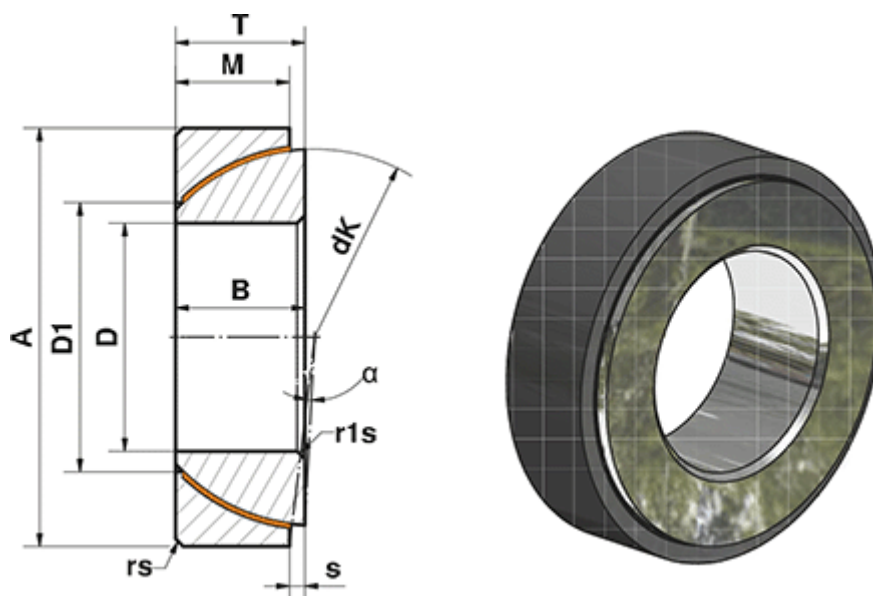

A	= 310	rs, r1s min	= 3
a (grader)	= 1.5	S	= 26
B	= 70	Statisk belastning C0 (kN)	= 7725
D	= 200	T	= 70
D1	= 229.4	Vægt (g)	= 23800
dK	= 290		
Dynamisk belastning C (kN)	= 4635		
M	= 66		